

USERSIDE.BUSINESS

a simple and reliable tool

for monitoring, accounting and management

OPPORTUNITIES / COMPONENTS OF USERSIDE.BUSINESS

FULL CONTROL OF THE INFRASTRUCTURE

A property of a software product that allows administrators and users to account for, manage, monitor and configure any cable lines, equipment, facilities, technological objects.



EQUIPMENT ACCOUNTING

Functionality that allows you to keep records and control over the hardware used in the enterprise.

DYNAMIC INTERACTIVE ONLINE MAP

A software product that provides users with the ability to view and interact with equipment overlaid on map data in real time via a local network or the Internet.



THE ALL-ROUNDER

All objects and sections of the product are deeply interconnected, providing more options for solving problems.

CUSTOMER/STUDENT/PATIENT/ANYONE BASE

A function of a software product that allows you to store and manage information about customers, perform related work, and accumulate interaction history.



DATA SECURITY AND CONFIDENTIALITY

Important properties of a software product that ensure the protection and confidentiality of information stored and processed by the application. Access to data can be divided both functionally and geographically.

The system is adapted to work from a computer, tablet and smartphone from anywhere in the world. Accessibility and low entry threshold for users: a simple, friendly and intuitive clear interface does not require lengthy staff training to use.

USERSIDE.BUSINESS WHAT IS THIS?

TEN TIMES LOWER PRICE

There are large international analogues that have a high price tag, and not many companies can afford such solutions.



17 YEARS OF EXPERIENCE

We have created this niche in the telecoms sector ourselves, and we are constantly improving in our work with 1200+ companies from 23 countries, and now we offer our skills in other sectors of the economy.



SAFETY

Reliable protection of your data: no cloud solutions (THIS IS AN ADVANTAGE!). The data is stored on your server and only you manage it.



INTEGRATION

The product has an extensive API and allows for mutual integration with third-party applications and equipment.



WORKING WITH LARGE AMOUNTS OF DATA

We can quickly process and display a large number of interactive objects. 200 thousand or 1 million or more is not a problem.



REPUTATION

A large number of clients and long-term contracts, experience of high-quality implementation, support and technical support of various profiles and levels - such contractors do not fail and do not disappear.





For whom **USERSIDE.BUSINESS**

FOR WHOM USERSIDE.BUSINESS?

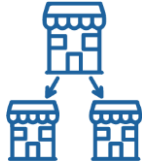

LARGE CHAIN COMPANIES

Chain stores, pharmacies, banks, postal companies with an extensive structure across the country/region.



MANUFACTURING ENTERPRISES

Plants, factories, and complexes.



SMART CITY / SAFE CITY

Self-Government Authorities.

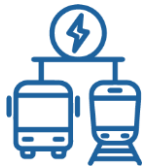

ELECTRIC TRANSPORT

Trolleybuses, trams, taxis with networks of intermediate equipment.



COMMUNAL / MUNICIPAL INSTITUTIONS

Cities, administrations, municipalities, enterprises.



TRANSPORT NETWORKS

Roads, railways, gas transportation, electricity distribution and similar companies.



STORAGE AND LOGISTICAL COMPANIES

With a large number of premises, transport and communications.



RESIDENTIAL AND HEALTHCARE COMPLEXES

Large hotels, hospitals/clinics, recreational complexes, gardening associations.



AGRICULTURAL COMPANIES

Agricultural holdings, farms with large fleets of machinery, land and premises.

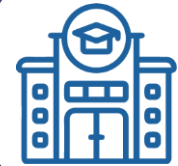

EDUCATIONAL INSTITUTIONS

Educational institutions with many buildings and a powerful communication and technology system.



FOR EVERYONE ABSOLUTLY

With a complex organisational structure, a large amount of equipment and an extensive communication system.



LARGE CHAIN COMPANIES

Specificity:

Postal companies, banks, chain stores, pharmacies, retailers, petrol stations, etc. - any business with multiple points of presence, and therefore an extensive office structure across the country/region.

Userside.Business solutions:

- Placement and management of all objects/outlets on the map. Accounting, monitoring of equipment at each facility, placement of cables, surveillance cameras, etc., which simplifies control over the system's health and provides instant access to information on a specific facility.

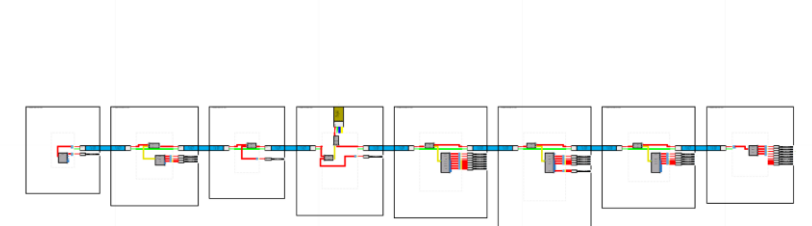
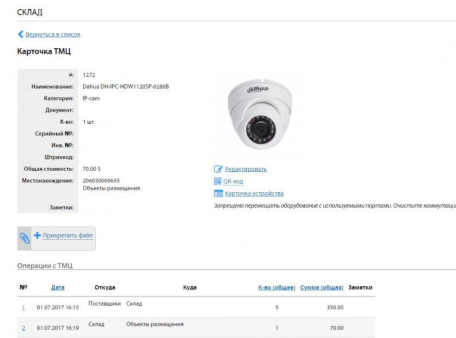



SMART CITY/ SAFETY CITY

Specificity:

Municipalities and administrations at different levels.

Userside.Business solutions:

- Placement and management of all objects/outlets on the map.
- Accounting, monitoring of equipment at each facility, placement of cables, surveillance cameras, etc., which simplifies control over the system's health and provides instant access to information on a specific facility.

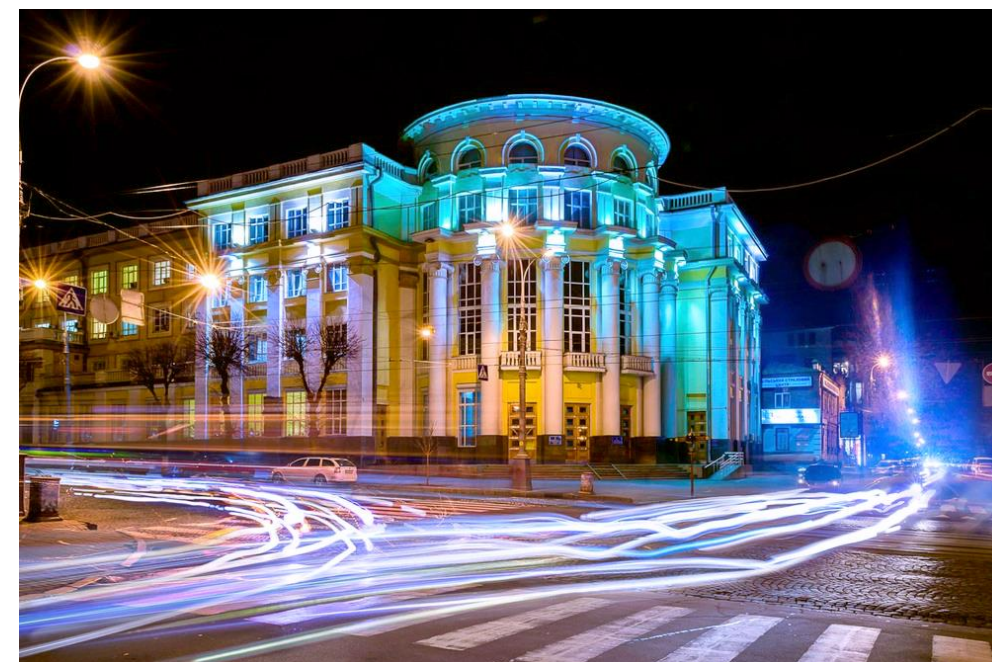

Example:

"Vinnytsia Information Centre" has implemented UserSide and launched the Safe City system, which includes accounting and management of video surveillance infrastructure, data recording and management.

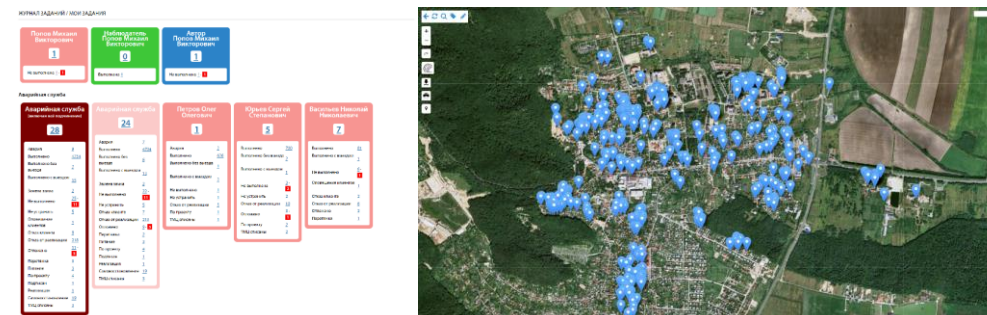



COMMUNAL / MUNICIPAL INSTITUTIONS

Specificity:

Utilities services - institutions and enterprises in cities. Various departments and divisions of municipalities, cities and administrations of various levels.

Userside.Business solutions:

Organisation of the work of dispatch centres and support/operational services (by type 1580) - subscriber requests, accounting, operation and tracking of emergency crews, etc.

Accounting for communications, wells, poles and other elements of the infrastructure elements.

- Traffic lights and other related facilities.
- Accounting for municipal power grids, including the organisation of a call centre and emergency crews.
- Warning networks (civil defence, air raid sirens, etc.).

Example:

Chernivtsi City Council has implemented UserSide to support the work of the municipal contact centre 1580 to organise the reception of applications from the public and to carry out emergency and routine maintenance. Using the product allows you to perform the following tasks in a short time and at minimal cost.

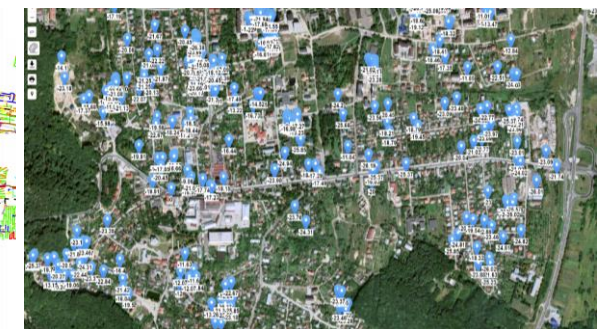
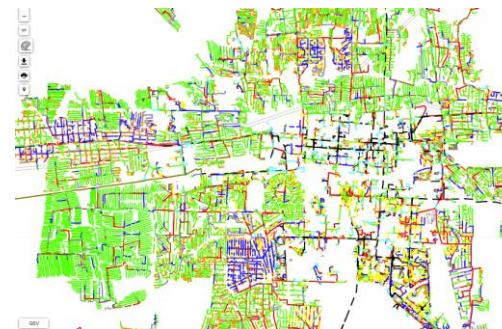

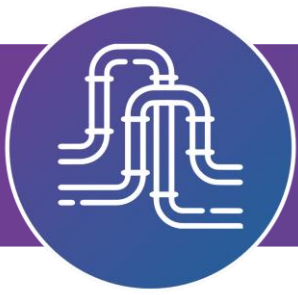

TRANSPORT NETWORK

Specificity:

Road companies (motorways), gas transmission and distribution companies, railways, etc.

Userside.Business solutions:

- Accounting for cable facilities and communication lines, both owned and leased.
- Accounting for transport networks.
- Accounting and tracking of special equipment.
- Tracking and management of emergency and work crews.
- Map including visualisation, indication of infrastructure elements, etc.
- Understand the intersection of different networks within the road sector - main communication cables, electricity, gas networks, etc. - for effective planning of various types of related works.
- Work with object statuses, lease management, etc.

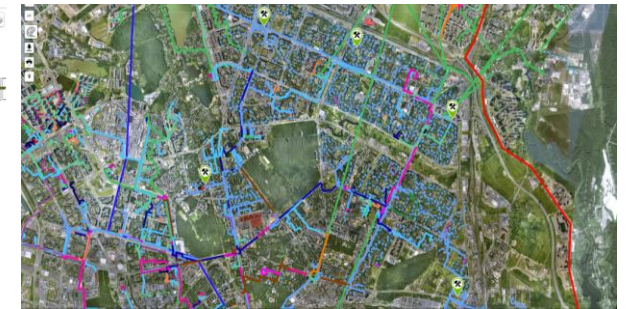
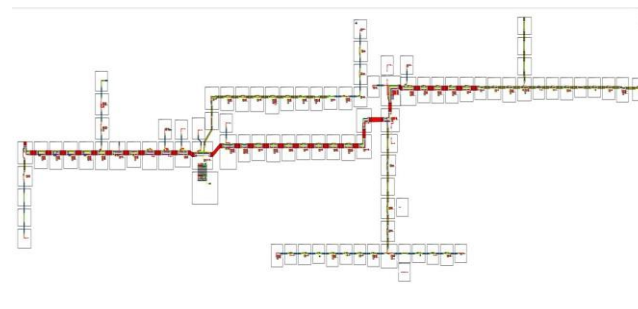
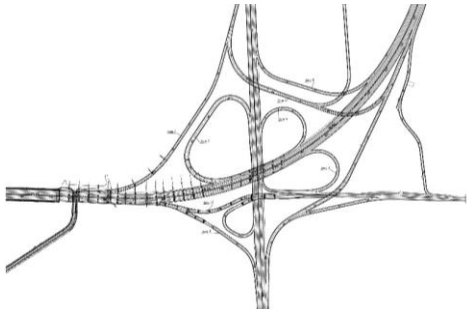



STORAGE AND LOGISTICAL COMPANIES

Specificity:

Companies with a network of warehouses, logistics facilities, and company vehicles.

Userside.Business solutions:

- Accounting and monitoring of the vehicle fleet, including tracking GPS positions.
- Accounting and monitoring of buildings and warehouses.
- Work with surveillance cameras, easy and quick access to any corner of your extensive business.
- Monitoring of warehouse capacities, simplification of warehouse workload accounting.
- Tracking the movement of goods.
- Order accounting system, etc.

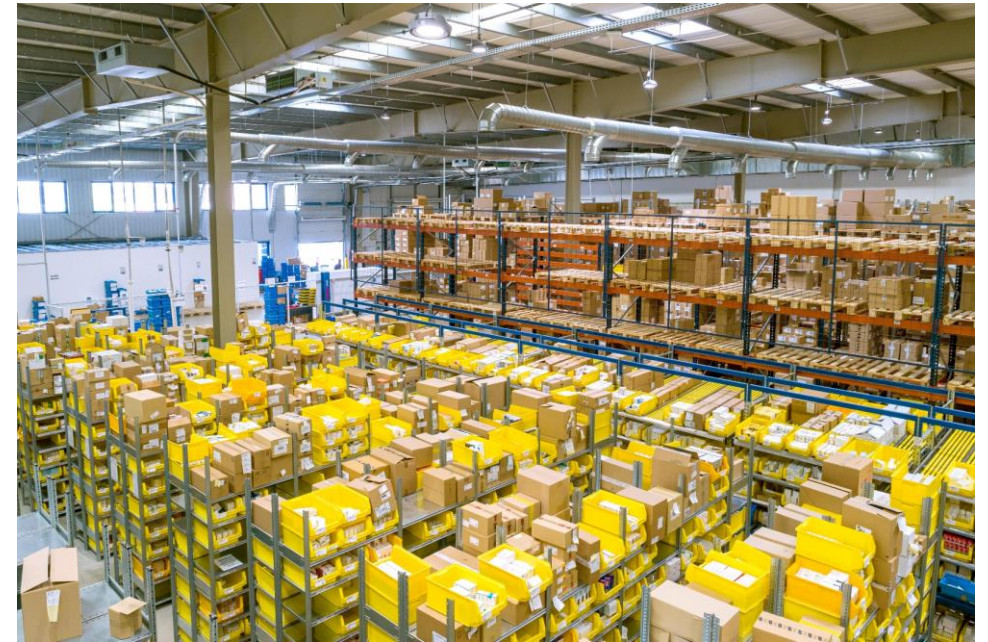

ПЕРСОНАЛ / ТАБЕЛЬ ПОСЕТ

Сентябрь 2024

№	Сторонний	Посет	01	02	03	04	05	06	07	08	09	10	11	12	13	14	15	16	17	18	19	20	21	22	23	24	25	26	27	28	29	30	31	Резерв	Присут	Отсут		
1	Иванов И.И.	Миниист																																				
2	Петров П.П.	Миниист																																				
3	Сидоров С.С.	Склад																																				
4	Кузнецов К.К.	П.департамент																																				
5	Лебедев Л.Л.	Испытатель																																				
6	Зайцев З.З.	Сл.инженер																																				
7	Смирнов С.С.	Сл.инженер																																				
8	Попов П.П.	Менеджер																																				
9	Соловьев С.С.	Склад																																				
10	Михайлов М.М.	Миниист																																				



СКЛАД

Карточка ТМЦ

ИД: 1272

Наименование: Духов СВ-РС КСН1120SF-02008

Категория: Ш.Склад

Длина: 1 шт.

Серийный №: 2080000065

Имя №: Объект размещения

Страна: Беларусь

Общая стоимость: 70.00 \$

Местонахождение: Объект размещения

Заметки:

Применить фильтр

Описание с ТМЦ

№	Дата	Откуда	Куда	Кол.объект	Сумма.объект	Заметки
1	01.07.2017 16:15	Поставщик	Склад	5	350.00	
2	01.07.2017 16:19	Склад	Объект размещения	1	70.00	

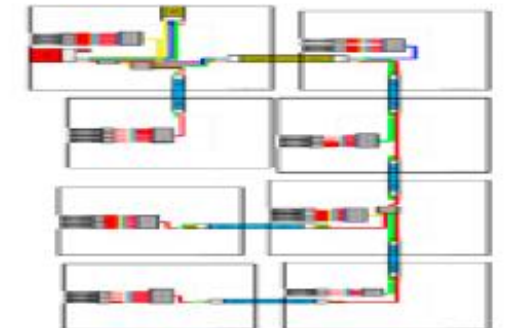



RESIDENTIAL AND HEALTHCARE COMPLEXES

Specificity:

Hotels and hotel chains, recreation centres, sanatoriums, large hospitals, clinic chains. Residential complexes, townhouses, townships, housing management companies.

Userside.Business solutions:

- Accounting for buildings, rooms, wards, houses and their internal networks (sockets, Wi-Fi points, IP phones, network cables, other equipment).
- Surveillance cameras.
- Accounting for employees, as well as guests or patients.
- Work with subscriber requests in management companies, a system for responding to requests, etc.

Example:

A large resort and recreational complex uses UserSide to manage and account for computer networks and trunk lines on the territory of the complex. Accounting for services, contractors, and service tenants. Monitoring and control of equipment and network performance.

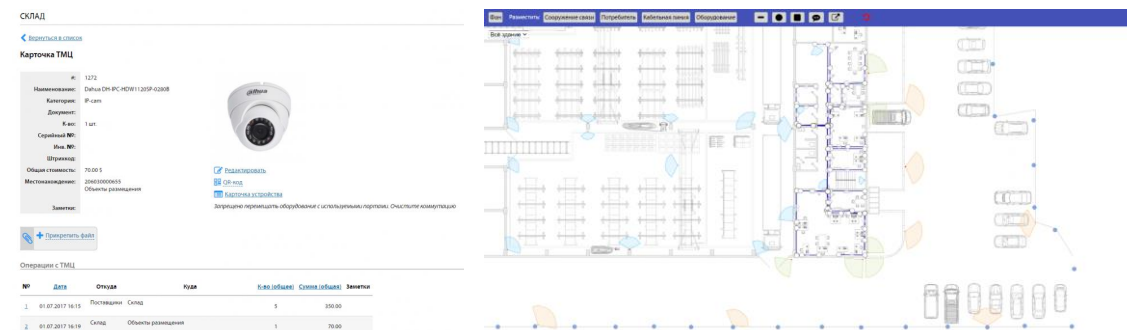



AGRICULTURAL COMPANIES

Specificity:

An extensive network of fields and agricultural facilities, farms, greenhouses with a fleet of agricultural machinery, equipment of any complexity or just surveillance cameras.

Userside.Business solutions:

- Map. Fields and crops accounting, including visual accounting.
- Display of information from sensors with geo-referencing to a specific location.
- Accounting and monitoring of agricultural machinery, tracking its GPS position.
- Tracking of personnel, field maintenance teams, and farms.
- Accounting for equipment in agricultural complexes, greenhouses, farms, etc.

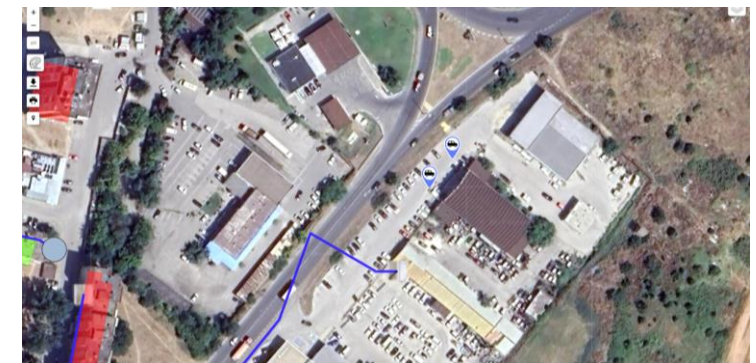
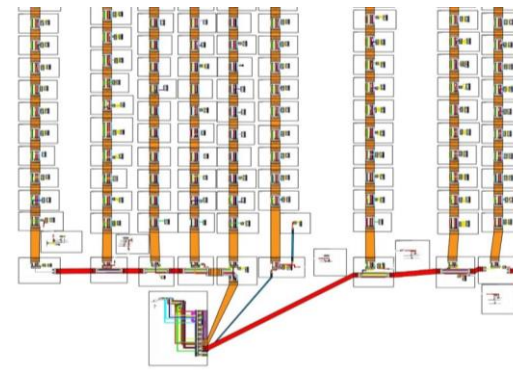



EDUCATIONAL INSTITUTIONS

Specificity:

Large higher education and other educational institutions with buildings, educational laboratories, campuses, etc., i.e., with a large number of networks and facilities at their disposal.

Userside.Business solutions:

- Free academic licenses for basic functionality UserSide.
- Accounting for computer networks and equipment, Internet coverage, etc.
- Possibility to involve students in documenting and network accounting as part of academic activities.
- Possibility of professional training for students of technical universities based on our industry-specific solution.
- Transfer of experience of Userside specialists for a deeper study of the practical of the profession.

Example:

Vinnitsya National Technical University uses UserSide in the process of distance learning in disciplines related to computer networks. This has made it possible to significantly simplify the use of physical network stands in online learning. UserSide is also used to provide technical support for the Internet infrastructure of the university's equipment and premises.

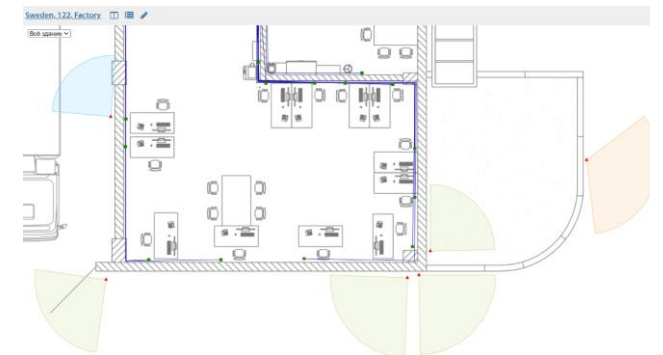
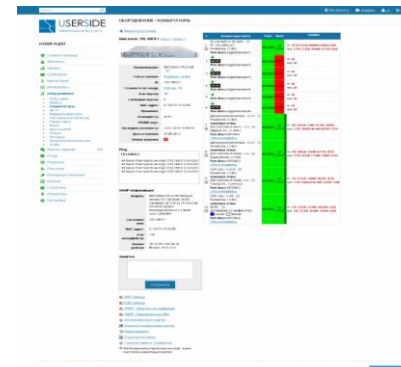



FOR EVERYONE ABSOLUTLY

Specificity:

Local networks of internal small service transport, recreation and entertainment complexes and parks (golf clubs, amusement parks, etc.). Other enterprises with cable networks, surveillance cameras, transport and the need to control the movement of service teams/vehicles and/or customer requests, etc.

Userside.Business solutions:

- Accounting for computer, telecommunications, any technical equipment, surveillance cameras with indication of surveillance sectors, wifi/radio equipment.
- Any communications (electricity, communication, etc. cable networks, pipeline networks).
- Work with building plans to plan the optimal placement of cables, networks, communications, and equipment.
- Sensor monitoring, ability to scan equipment status and take readings.
- The ability to organise any type of work with notifications, time control, prioritization and escalation of tasks.
- Accounting for staff and personnel of the company's divisions.
- Accounting of any type of transport and live GPS position tracking on the map.
- Accounting for clients of any profile (subscribers, consumers, students, patients, etc.) and setting up interaction with them, including accounting for requests and tracking actions for each case.



AND THE MOST IMPORTANT!



We have many years of experience, recognition and daily use by hundreds of companies from many countries, including large providers, backbones, traffic exchange points, and mobile operators. We take part in many international conferences, have been "cooking" in the telecoms community for many years and follow the trends.

Visit the "Our clients" page on our website to find out more:
<https://www.userside.eu/en/clients>

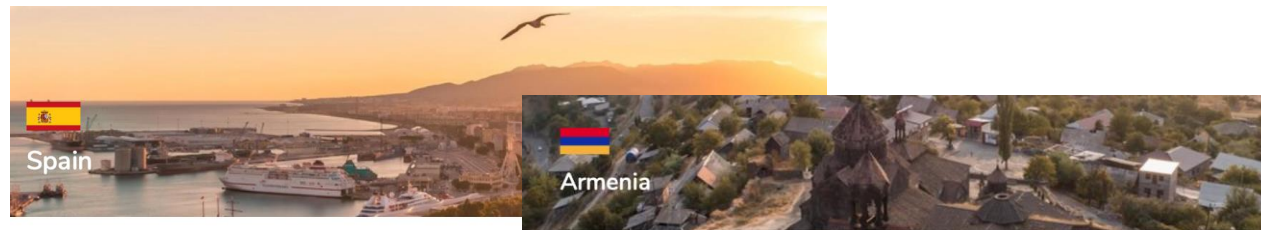
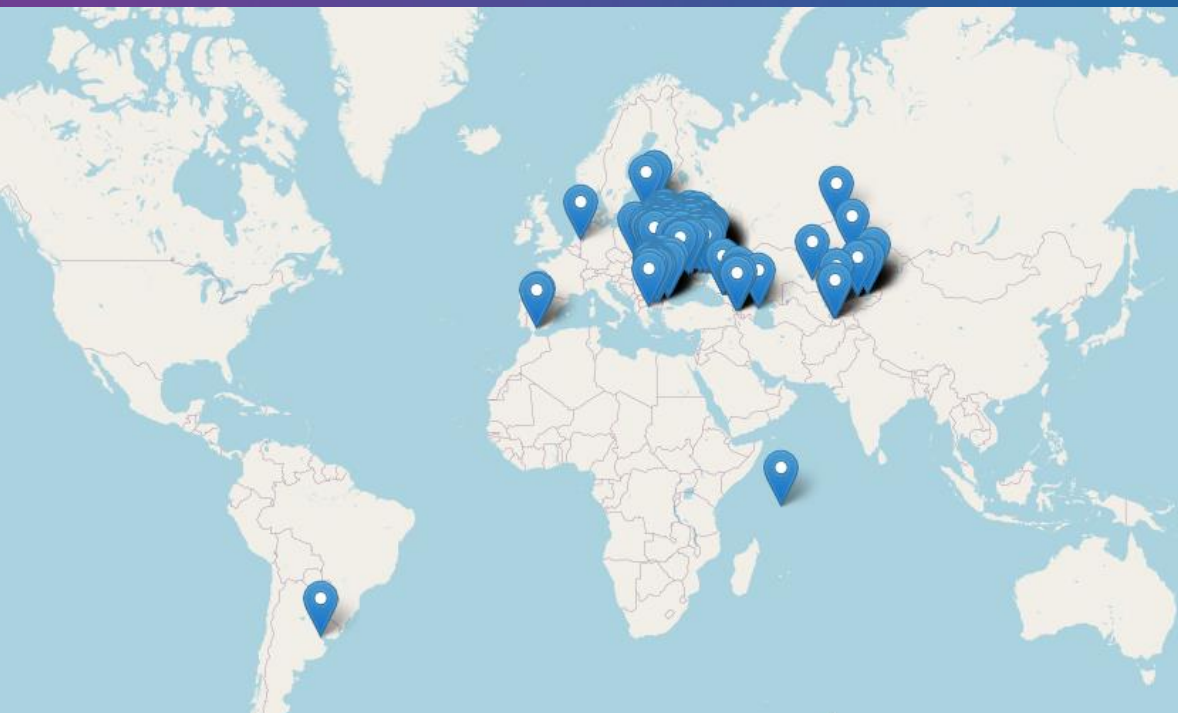

Olivenet Data Centers
 Málaga
<http://olivinet.eu>

OLIVENET NETWORK
 Province of Málaga, Marbella
<https://olivinet.es>

Aranea
 Ararat
<http://www.aranea.am/>

Arpinet
 Vaghharshapat
<http://arpinet.am/>

INTERCONNECT
 Yerevan

InterLink
 Yerevan
<http://interlink.am>



Seychelles

Prime Systems
 Kotayk Province, Charentsavan
<http://www.primesystems.am/>

SkyNet
 Sevan
<http://tins.am>

Гиганет
 Nor Hachn
<http://www.giganet.am>

Регионнет
 Martuni
<http://www.regionnet.am>

Intelvision
 Victoria
<https://www.intelvision.sc/>



Latvia



Bulgaria

Netvision
 Riga
<http://www.netvision.lv>

РетНет (RETN Baltic)
 Riga
<https://retn.net/ru/>

ComNet Bulgaria Holding
 Bourgas
<http://www.comnet.bg>

Digicom
 Burgas
<http://www.digicom.bg>

ProLan
 Sofia
<http://prolan.bg/>

svogelan
 Sofia Province, Svoge
<http://svogelan.net>

Алфа Нет БГ
 Stara Zagora

Бол Бг Изток
 Sofia City Province, Lozen
<http://bol-bg.com>



D Cloud
 Karaganda
<http://www.fishnet.kz>

EsilNet
 Petropavl
<http://esilnet.com/>

Meganet
 Almaty
<http://meganet.kz>

NLS Kazakhstan
 Almaty
<http://www.nls.kz>

SMARTNET
 Almaty
<http://www.smartnet.kz>

Казтелепорт
 Almaty
<http://kazteleport.kz/>

Кайнар АКБ
 Almaty Region, Taldykorgan
<http://kainar-tv.kz/>

Ситилан
 Balkonur
<http://sitil.ru>



POSSIBLE BIASES



"- I don't think we need this product. Our employees will be against anything new and additional work. An engineer with network diagrams in his notebook will be against it, because he will no longer be indispensable."

"- Excel and Outlook are enough for us, why else would we spend money on any other software?"

"- We have our own programmer sysadmin who has been writing software for us for the last 5 years and constantly demands more and more money. We're fine with that!"

The purpose of USERSIDE.BUSINESS is to improve the state of processes in the company as a whole, not to make work more comfortable for individual employees. The result of implementing our solution is a more stable business, not fewer complaints from employees.



BRIEF TECHNICAL DESCRIPTION OF **USERSIDE.BUSINESS**

COVERAGE

- Interactive map of service coverage that interacts with various geo-services and systems.

Objects:

- Coverage buildings;
 - Communication/network nodes;
 - Couplers;
 - Pillars;
 - Wels;
 - Cable lines and networks;
 - Cable channels ;
 - Radio equipment.
- GPS positions of employees, crews, and vehicles.
 - Depth of coverage by subscribers and traffic/service volume in buildings.
- The ability to visually display high/low activity of buildings on the map, which allows you to visually identify problem areas of the network.
 - Customised colour display of objects.
 - The ability to navigate to any object directly from the map with one click.
 - Possibility of visual identification of network coverage by various parameters:
 - depending on the density of cables;
 - based on the type of network laying (air, sewerage, etc.);
 - own unique markings for large objects.

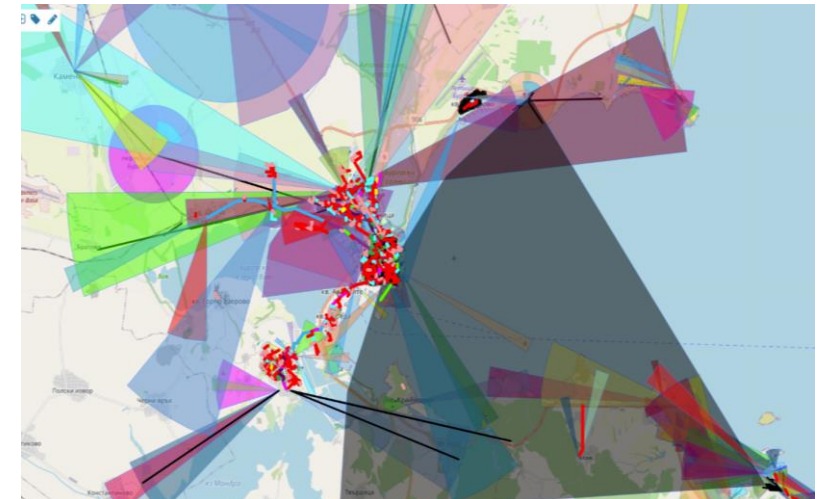
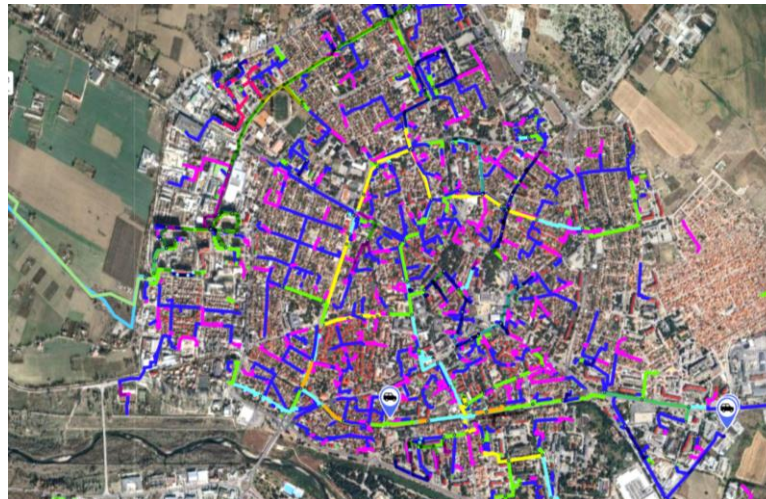
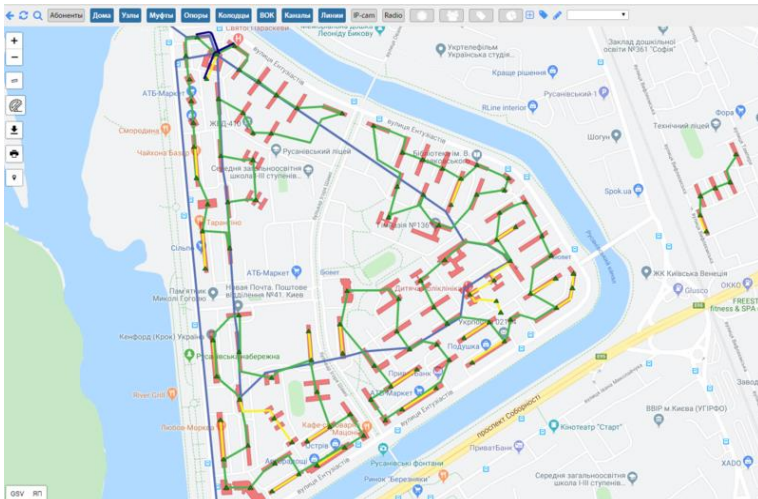

CABLE LINES AND NETWORKS

- Customised catalogue of cables.
- The length can be specified manually or calculated automatically by the geocoder using coordinates.
- Arbitrary objects on the route (manholes, poles, transit in channels).
- Arbitrary recordings both on objects along the route and in any specific location.
- Each type of cable has its own colour and can be switched to any object in the system, including displaying information about the cable's endpoint.
- Supports cables of any density in any quantity.
- You can attach files (traces, etc.) for the network as a whole and for each cable.

- The ability to break the network at any arbitrary point.
- Fiber optic routes, trunk cables.
- Calculation of the route of connections (when specifying the start and end points between which you want to create a route).
- Arbitrary labels (for example, for projects, underground network, etc.).
- Planning mode (fixation of objects that have not yet been built or do not exist).
- Comments on fibers.
- Various types of endpoints (including visual ones on the diagram).

USERSIDE НАСТРОЙКА / КАБЕЛЬНЫЕ ЛИНИИ

Возврат в каталог

Каталог кабелей

Тип кабельной линии: ВОЛС

Производитель: ТКО

Маркировка: 144F

Емкость кабеля: 144

Расстигающее усилие (кН): 0

Затухание (дБ/км): 0

Цвет кабеля на схеме коммутации: [Color Selection]

Заметки:

Расчетка проводников кабеля

#	Модуль	Нить/полеза	Жила/волокно
1	синий	оранжевый	синий
2	синий	оранжевый	оранжевый
3	синий	зеленый	зеленый
4	синий	коричневый	коричневый
5	синий	серый	серый
6	синий	белый	белый
7	синий	красный	красный
8	синий	черный	черный
9	синий	желтый	желтый
10	синий	фиолетовый	фиолетовый
11	синий	розовый	розовый
12	синий	бирюзовый	бирюзовый

КАБЕЛЬНА ІНФРАСТРУКТУРА / РОЗПОДІЛЮВАЧІ/УЩІЛЬНЮВАЧІ

Режим роботи: поточний · змішаний · планування

Додати

Мітки: Без мітки · PON

Групові дії

№	Найменування	Розміщення	К-ть адаптерів	Нотатки
1	A-GEAR PLC Splitter 1x4 SC/UPC	Волошкава (опора) #311 (Урожайна) (муфта) #323	1-4	
2	A-GEAR PLC Splitter 1x16 SC/UPC	Миру (опора) #400 (муфта) #404	1-16	
3	A-GEAR PLC Splitter 1x16 SC/UPC	Мисливська (опора) #326 (Мисливська) (муфта) #327	1-16	
4	A-GEAR PLC Splitter 1x4 SC/UPC	Молодіжна (опора) #401 (муфта) #406	1-16	
5	A-GEAR PLC Splitter 1x4 SC/UPC	(опора) #294 (Демидівська) (муфта) #328	1-4	
6	A-GEAR PLC Splitter 1x3 SC/UPC	(опора) #295 (Демидівська) (муфта) #329	1-3	
7	A-GEAR PLC Splitter 1x3 SC/UPC	(опора) #297 (Демидівська) (муфта) #331	1-3	
8	A-GEAR PLC Splitter 1x3 SC/UPC	Радянська (опора) #398 (муфта) #405	1-12	
9	A-GEAR PLC Splitter 1x12 SC/UPC	Урожайна (муфта) #322	1-12	

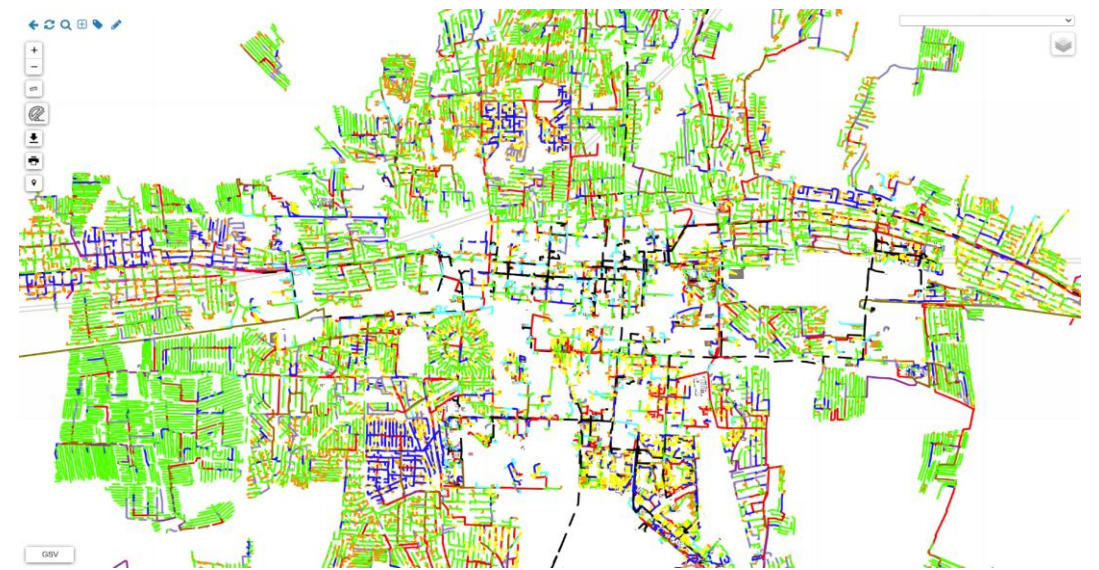

CONSUMERS • CLIENTS • ABONENTS

- A list of customers with extensive options for customisation and filtering by various parameters.
- Ability to set up labels and visual attributes for different customer categories.
- A database of VIP customers.
- Personal account of a customer.
- History of customer activity.
- History of interaction with the customer: requests, diagnostic actions, applications and their processing, calls, etc.
- Registration of incoming calls by customer, creation of tickets and tasks.

- General statistics: activity graphs, customer coverage, etc.
- Support for customer disconnection processes, a database of former customers, which helps to quickly return and reactivate the account if necessary.
- Generalised financial statistics: graphs of total income from subscription fees (service fees) by tariff plan/category of customers.
- Formation of documents - according to templates and arbitrary ones.
- Customised additional fields.

Фільтр
Групувати дії

Результатів: 2920 • Сторінка 1 2 3 4 5 ... 11 12 13 14 15 ... 26 27 28 29 30 ▶

№	Статус	Особовий рахунок	Прізвище Ім'я По-батькові	Баланс	Кредит (\$)	Тариф	Дата підключення	Телефон	Адреса
1201	Активний	50021720	Філатов Сава Михайлович	1726.00	0.00	1	26.06.2009	624113 (SMS)	Київ, Ентузіастів, 298#047-1 кв. 25
1202	Активний	50021719	Федотова Зінаїда Петрівна	130.00	0.00	5	15.01.2007		Київ, Ентузіастів, 298#047-1 кв. 19
1203	Пауза	50021718	Орлов Костянтин Володимирович	59.00	0.00	8	19.07.2006	923893 (SMS)	Київ, Ентузіастів, 298#047-1 кв. 38
1204	Активний	50021717	Фомін Олег Валерійович	1733.00	0.00	4	02.08.2011		Київ, Ентузіастів, 298#047-1 кв. 20
1205	Стоп	50021716	Котова Зоя Тимофіївна	-212.00	0.00	2	03.08.2015	050914200 (SMS)	Київ, Ентузіастів, 298#047-1 кв. 133
1206	Активний	50021715	Блинов Ігор Дмитрійович	1234.00	0.00	1	15.04.2015	050847376 (SMS)	Київ, Ентузіастів, 298#047-1 кв. 179
1207	Активний	50021714	Симонова Лідія Анатоліївна	1398.00	0.00	4	19.05.2007		Київ, Ентузіастів, 298#047-1 кв. 100
1208	Активний	50021713	Іванова Олександра Русланівна	1687.00	0.00	2	04.08.2008	761643 (SMS)	Київ, Ентузіастів, 298#047-1 кв. 145
1209	Активний	50021712	Кондратьєв Михайло Миколайович	444.00	0.00	7	03.09.2015	824569 (SMS)	Київ, Ентузіастів, 298#047-1 кв. 160
1210	Активний	50021711	Андрійов Олег Русланович	1090.00	0.00	2	13.11.2007		Київ, Ентузіастів, 298#047-1 кв. 78
1211	Активний	50021710	Дорофеева Елена Семенівна	736.00	0.00	6	04.12.2003		Київ, Ентузіастів, 298#047-1 кв. 145
1212	Активний	50021709	Рогова Любов В'ячеславівна	883.00	0.00	3	14.08.2013	516683 (SMS) 050135880 (SMS)	Київ, Ентузіастів, 298#047-1 кв. 174
1213	Активний	50021708	Назаров Вадим Валерійович	1835.00	0.00	7	20.06.2014		Київ, Ентузіастів, 298#047-1 кв. 110
1214	Активний	50021707	Горшкова Лідія Філіпівна	1100.00	0.00	5	03.12.2006	739564 (SMS)	Київ, Ентузіастів, 29 кв. 49
1215	Активний	50021706	Ситников Віталій Данилович	240.00	0.00	3	05.02.2009	462840 (SMS)	Київ, Ентузіастів, 29 кв. 68
1216	Активний	50021705	Новикова Тетяна Юріївна	480.00	0.00	5	14.07.2006		Київ, Ентузіастів, 29 кв. 3
1217	Активний	50021704	Сорокін Вадим Ігоревич	371.00	0.00	1	27.11.2006	050571012 (SMS)	Київ, Ентузіастів, 29 кв. 78
1218	Активний	50021703	Большакова Єкатерина Григоріївна	1811.00	0.00	8	25.05.2015		Київ, Ентузіастів, 29 кв. 3
1219	Активний	50021702	Ільїн Ілля Натанович	1928.00	0.00	2	28.08.2014	050405367 (SMS)	Київ, Ентузіастів, 29 кв. 65
1220	Активний	50021701	Артемев Георгій Давидович	570.00	0.00	3	28.10.2006		Київ, Ентузіастів, 29 кв. 62
1221	Активний	50021700	Уварова Юлія Леонідівна	1712.00	0.00	4	01.11.2006	050454442 (SMS)	Київ, Ентузіастів, 29 кв. 55
1222	Активний	50021699	Шилов Егор Давидович	1265.00	0.00	2	08.10.2010		Київ, Ентузіастів, 29 кв. 5
1223	Активний	50021698	Ковальова Серафіма Дмитріївна	941.00	0.00	7	30.05.2012		Київ, Ентузіастів, 29 кв. 56

АБОНЕНТИ / ПЕРЕЛІК

Фільтри відображення
Потенційні абоненти (Так) Фільтр або Скасування

Ще:
Зберегти як власний фільтр
Групувати за...

+ Додати потенційного абонента
≡ Перелік завдань

Групувати дії

Результатів: 52

№	Договір	IP	IP/Областис	Прізвище Ім'я По-батькові	Баланс	Тариф	Адреса (тел)	Активність у мережі
1				♥	0.00		Київ, Ентузіастів, 3 кв. 84	06.03.2024 09:13
2				♥	0.00		Київ, Ентузіастів, 3 кв. 82	15.02.2019 16:44
3				♥	0.00		Київ, Ентузіастів, 3 кв. 81	06.03.2024 10:13
4				♥	0.00		Київ, Ентузіастів, 3 кв. 79	07.10.2019 11:15
5				♥	0.00		Київ, Ентузіастів, 3 кв. 78	10.07.2023 11:13
6				♥	0.00		Київ, Ентузіастів, 3 кв. 75	07.10.2019 10:58
7				♥	0.00		Київ, Ентузіастів, 3 кв. 74	06.03.2024 10:13
8				♥	0.00		Київ, Ентузіастів, 3 кв. 72	18.12.2018 10:31
							Київ, Ентузіастів,	06.03.2024

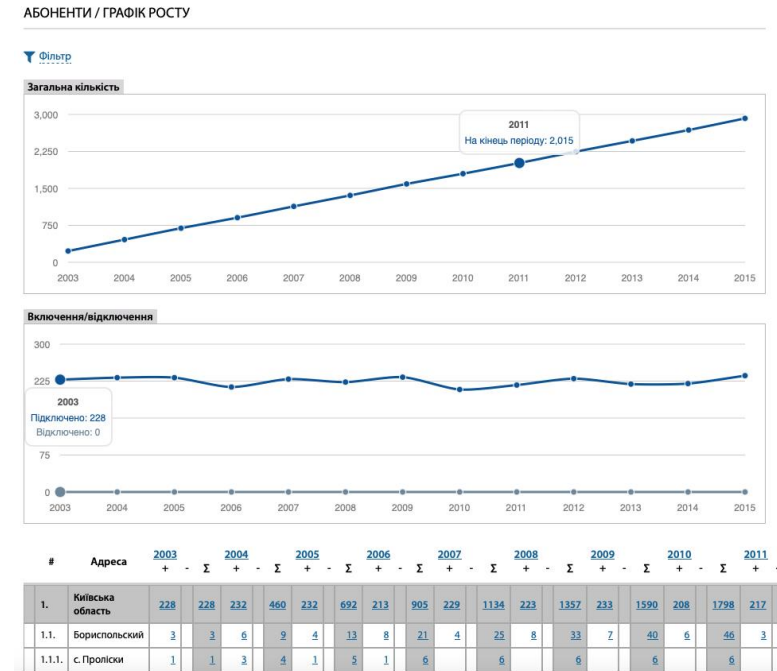

SWITCHING IN THE COMMUNICATION NODE/COUPLING

Interactive. A wizard is available for bulk fibre switching.

Allows you to switch:

FIBRE OPTICS;

UTP lines;

ODF;

splitters/seals;

switches, radio equipment;

media converters;

system and other devices.

- The switch has a variety of color markings, including arbitrary ones.
- Labels are available, and connected equipment and subscribers are automatically displayed.
- Quick transition to the final switching object.
- QR codes: generate codes that can be pasted on a coupling, communication node, switch cabinet, box to facilitate accounting and identification of objects.

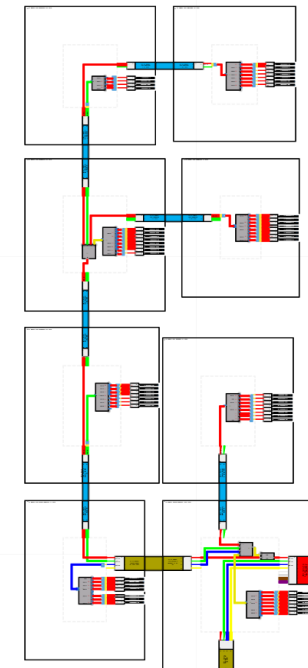
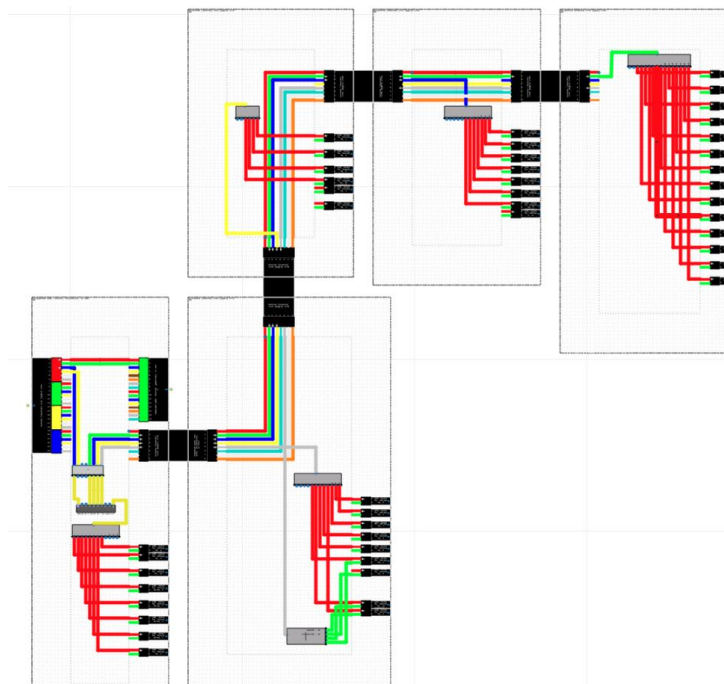
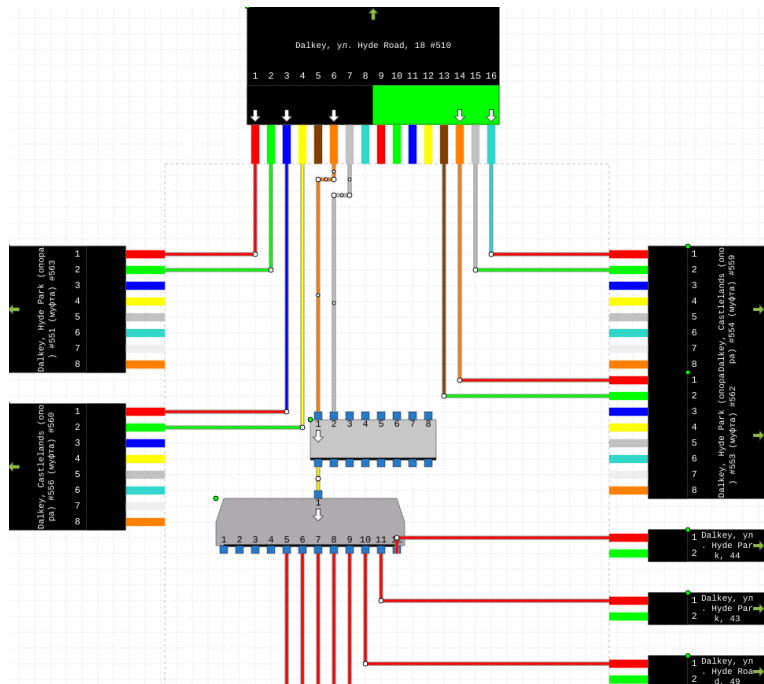

EQUIPMENT

- Unlimited number of interfaces to configure.
- Typical database of switches and radio equipment with default parameters.
- Online status of interfaces, equipment units, current status, speed, error counter.
- Information about switching of each interface.
- Ability to disable/enable a piece of equipment.
- ARP/FDB tables.
- For certain equipment, firmware version control and a summary report for all equipment units are available.
- Linking to the warehouse module (with warehouse accounting operations, serial/inventory numbers, etc.).
- MAC address history for all interfaces of all equipment, including detection of viruses and other malicious activity.
- Automatic (logical) switching of subscribers to interfaces.
- Automatic periodic polling of device status.
- Separate functionality for PON optical networks (OLT, ONU/ONT). Hot-swappable device with switching preservation.
- Building a switching structure diagram for each interface.
- Functional marking of equipment (UPLINK/DNLINK interfaces).

ОБЛАДНАННЯ / PRINTERS

+ Додати

№	Найменування	Розташування	IP/MAC	Портів	Активність
1	HP LaserJet M127fw with Wi-Fi	Київ, Офіс компанії (Центральний Офіс компанії) #359	10.1.20.16	1	19.01.2021 21:55
2	Xerox Phaser 6500N (6500V_N)	Київ, Офіс компанії (Центральний Офіс компанії) #359	10.1.20.17	1	06.03.2024 10:03



- ★ Головна сторінка
- 👤 Абоненти
- 📄 Тарифи
- 📧 Повідомлення
- 📊 Бухгалтерія
- 👥 Споруди зв'язку
- 🔌 Кабельна інфраструктура
- 🛠️ Обладнання
- 📁 Комунікатори
- 📶 OLT
- 📡 ONU/ONT
- 📻 Радіообладнання
- 🏠 Медіаковертори
- 🔧 Системні пристрої
- 📷 IP-cam
- 📱 IP-phone
- 🖨️ Printers
- 🌐 VLAN
- 📅 Журнал завдань
- 📦 Склад
- 🏠 Покриття
- 👤 Персонал

ОБЛАДНАННЯ / СИСТЕМНІ ПРИСТРОЇ

+ Додати

Мітки: Без мітки · PON

№	Найменування	IP/MAC	Портів	Портів вільно	Активність	Опис
1	Сервер HP ProLiant DL360 G6	10.1.20.1	2	1	30.05.2020 14:15	
2	Сервер HP ProLiant DL360 G6	10.1.20.2	2	1	04.01.2022 09:59	
3	Ноутбук Acer Aspire E5-511-P2HN	10.1.20.24	2	1	19.01.2021 21:45	
4	Ноутбук Acer Aspire E5-573G-P3NS	10.1.20.25	2	1	19.04.2023 13:35	
5	Ноутбук Dell Inspiron 5748	10.1.20.26	2	1	06.03.2024 10:03	
6	ПК HP EliteDesk 800 G1 TWR	10.1.20.27	2	1	19.04.2023 13:45	
7	ПК 457/11	10.1.20.28	2	1	08.08.2021 00:26	
8	ПК 457/12	10.1.20.29	2	1	19.04.2023 13:45	



ОБЛАДНАННЯ / КОМПОНЕНТИ

Вибір в опції

Вибір коду: 102.168.0.1

Навігація: Головна сторінка, Абоненти, Склад, Споруди зв'язку, Кабельна інфраструктура, Обладнання, Системні пристрої, Журнал завдань, Покриття, Персонал.

Мітки: Без мітки · PON

№	Найменування	IP/MAC	Портів	Портів вільно	Активність	Опис
1	Сервер HP ProLiant DL360 G6	10.1.20.1	2	1	30.05.2020 14:15	
2	Сервер HP ProLiant DL360 G6	10.1.20.2	2	1	04.01.2022 09:59	
3	Ноутбук Acer Aspire E5-511-P2HN	10.1.20.24	2	1	19.01.2021 21:45	
4	Ноутбук Acer Aspire E5-573G-P3NS	10.1.20.25	2	1	19.04.2023 13:35	
5	Ноутбук Dell Inspiron 5748	10.1.20.26	2	1	06.03.2024 10:03	
6	ПК HP EliteDesk 800 G1 TWR	10.1.20.27	2	1	19.04.2023 13:45	
7	ПК 457/11	10.1.20.28	2	1	08.08.2021 00:26	
8	ПК 457/12	10.1.20.29	2	1	19.04.2023 13:45	

Детальні дані про обладнання:

- Назва: ВСОМ05.F13108
- Умк установа: 102.168.0.1
- Становище по севару: 002,000
- Клас мережі: 10
- Скорочена назва: 5
- MAC-адреса: 8C:A4:F2:9:23:5A
- Примітки: 42 81
- Закладка: 1
- Пользователь: 12.01.2014 19:08:16
- Дата устаткування: 27.08.2013
- Планове обслуговування: 10.00

Результат сканування:

№	Найменування	IP/MAC	Портів	Портів вільно	Активність	Опис
1	Сервер HP ProLiant DL360 G6	10.1.20.1	2	1	30.05.2020 14:15	
2	Сервер HP ProLiant DL360 G6	10.1.20.2	2	1	04.01.2022 09:59	
3	Ноутбук Acer Aspire E5-511-P2HN	10.1.20.24	2	1	19.01.2021 21:45	
4	Ноутбук Acer Aspire E5-573G-P3NS	10.1.20.25	2	1	19.04.2023 13:35	
5	Ноутбук Dell Inspiron 5748	10.1.20.26	2	1	06.03.2024 10:03	
6	ПК HP EliteDesk 800 G1 TWR	10.1.20.27	2	1	19.04.2023 13:45	
7	ПК 457/11	10.1.20.28	2	1	08.08.2021 00:26	
8	ПК 457/12	10.1.20.29	2	1	19.04.2023 13:45	

RADIO EQUIPMENT AND SURVEILLANCE CAMERAS

- It can be installed both on a specific communication node and directly to the subscriber.
- Possibility of azimuth and sector configuration.
- Monitoring the signal strength of connected radio subscribers.
- The ability to display information about the signal strength of the equipment on the main page of the service.
- Display of images from surveillance cameras, control and monitoring.
- Monitoring of equipment activity/shutdown (with setting up notifications of problems via email/ SMS/ visual alerts).
- Interaction with the warehouse.
- Customised labels, additional fields, the ability to add files.

СКЛАД

[Вернуться в список](#)

Карточка ТМЦ

И: 1272
Наименование: Дача DH-IPC-HDW1120SP-02008
Категория: IP-сэм
Документ:
К во: 1 шт.
Серийный №:
Име. №:
Штрихкод:
Общая стоимость: 70.00 \$
Местонахождение: 20603000955
Объекты размещения:
Заметки:



[Реализовать](#)
[QR-код](#)
[Карточка устройства](#)

Запрещено перемещать оборудование с используемыми портами. Очистите комплектацию

[Прикрепить файл](#)

Операции с ТМЦ

№	Дата	Откуда	Куда	К-во (общее)	Сумма (общая)	Заметки
1	01.07.2017 16:15	Поставщик	Склад	5	350.00	
2	01.07.2017 16:19	Склад	Объекты размещения	1	70.00	

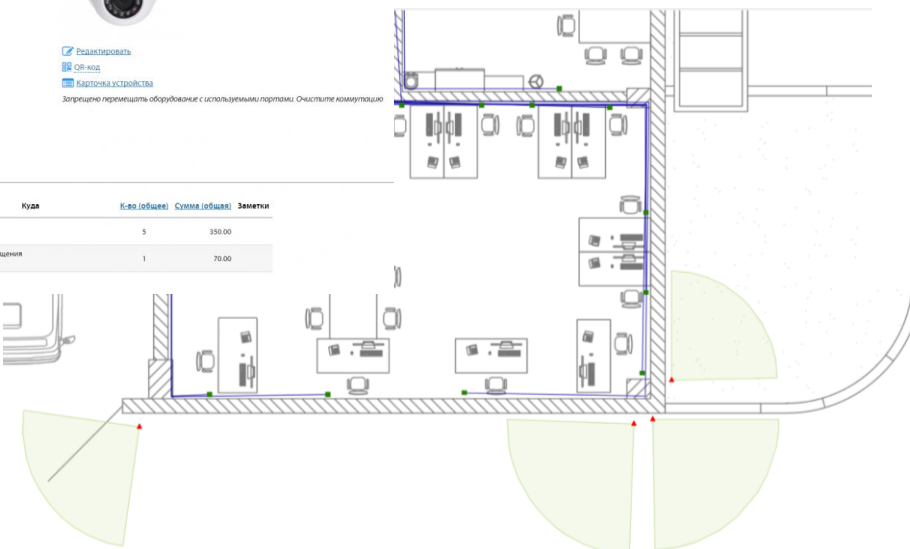

IP: 192.168.0.254 <http://> <telnet://>



Наименование: Ubiquiti Networks NanoStation 5

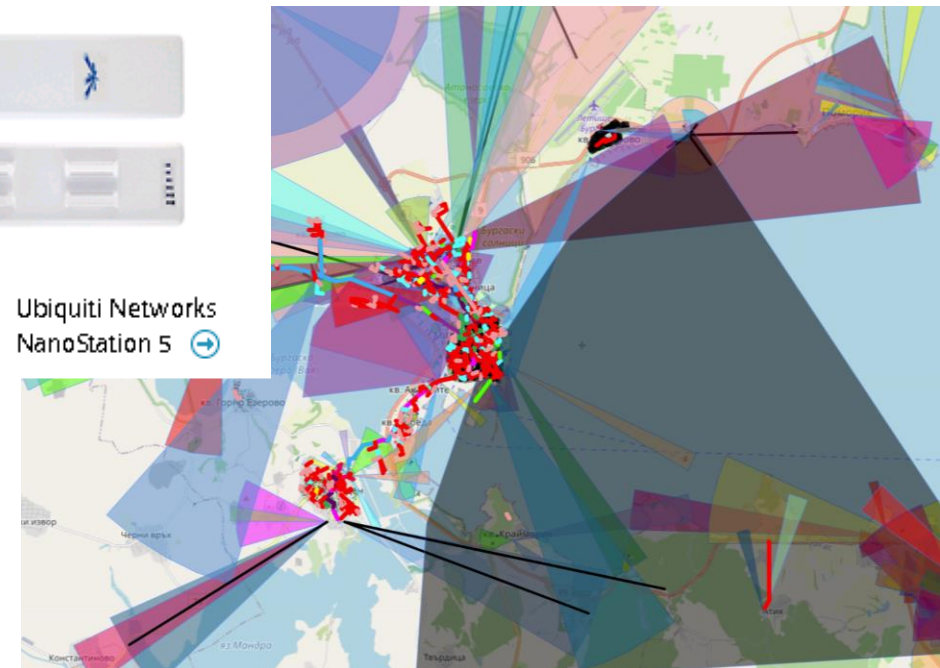

APPLICATIONS AND TASKS

- Any type of work with flexible settings.
- Automatic assignment of specialists and/or departments to a specific task by type of work and queue.
- Control of deadlines.
- Comments and task links.
- Statistics.
- Summary pages for a quick overview of statistics, a list of assigned tasks for yourself, your department, and all your departments.
- News - updates on tasks.
- Customised task statuses and standard comments.
- Ability to generate various documents, orders, etc.
- Remote closing of tasks.

- Displaying tasks on the map.
- Assigning subscribers/customers to tasks.
- Transfer of consumables, equipment, and other goods and materials to tasks.
- Periodic/regular tasks.
- Paying contractors (if necessary). Notify employees about tasks and new assignments for them.
- Send notifications in any convenient way: integration with email, SMS, Telegram, etc.
- You can 'pull up' the weather forecast in the task list to better manage the situation and plan internal or external work.

ЖУРНАЛ ЗАДАНИЙ / МОИ ЗАДАНИЯ

Попов Михаил Викторович

1

Не выполнено 1

Наблюдатель Попов Михаил Викторович

0

Выполнено 0

Автор Попов Михаил Викторович

1

Не выполнено 1

Аварийная служба

Аварийная служба
(включая все подчиненные)

28

Авария 2

Выполнено 4754

Выполнено без выезда 2

Выполнено с выездом 13

Заявка замка 2

Не выполнено 25

Не устранено 11

Отказ клиента 9

Отказ от реализации клиентов 1

Отказ клиента 8

Отказ от реализации 213

Отложено 11

Перегарка 3

Питание 3

По проекту 5

Подписки 1

Реализация 1

Самостоятельное ТМД списаны 3

Аварийная служба

24

Авария 2

Выполнено без выезда 5

Выполнено с выездом 13

Заявка замка 2

Не выполнено 22

Не устранено 11

Отказ клиента 3

Отказ от реализации ТМД списаны 1

Отложено 9

Перегарка 2

Питание 3

По проекту 5

Подписки 1

Реализация 1

Самостоятельное ТМД списаны 3

Петров Олег Олегович

1

Авария 2

Выполнено без выезда 628

Выполнено с выездом 1

Заявка замка 2

Не выполнено 1

Не устранено 1

Отказ от реализации ТМД списаны 1

Отложено 9

Перегарка 2

Питание 3

По проекту 5

Подписки 1

Реализация 1

Самостоятельное ТМД списаны 3

Юрьев Сергей Степанович

5

Выполнено 200

Выполнено без выезда 2

Не выполнено 3

Не устранено 2

Отказ от реализации 33

Отложено 3

По проекту 2

ТМД списаны 2

Васильев Николай Николаевич

2

Выполнено 81

Выполнено с выездом 1

Не выполнено 6

Не устранено 2

Отказ от реализации 6

Отложено 2

Оповещение клиентов 1

Перегарка 1

24.11.2015 Вт 12:50	Київ, Ентузавці, 5 кв. 144	Хайтовська Єкатерина Георгіївна - (20720) Київ, Бутушівська, 5 кв. 144 IP: 10.25.2.208 528510 (MMS)	Выполнено прострочено	Высокий приоритет Ремонт ДрТ Немає сигналу Виконується Відкладено	Бригада 3 ремонтів
24.11.2015 Вт 09:00	Київ, Русанівська Набережна, 8 кв. 40	Борисов Павло Рубенович - (20253) Київ, Русанівська Набережна, 8 кв. 40 IP: 10.25.9.253	Выполнено прострочено	Ремонт ДрТ Собака пошкодила кабель	Бригада 3 ремонтів
25.11.2015 Ср 14:00	Київ, Русанівська Набережна, 10 кв. 42	Мольцова Андрій Данилович - (20257) Київ, Русанівська Набережна, 10 кв. 42 IP: 10.25.1.1	Выполнено прострочено	Ремонт ДрТ Пошкодження розетку	Бригада 3 ремонтів
25.11.2015 Ср 12:00	Київ, Русанівський бульвар, 4 кв. 58	Ефимов Олег Ростиславович - (22509) Київ, Русанівський бульвар, 4 кв. 58 IP: 10.25.9.205 867286 (SMS)	Выполнено прострочено	Ремонт ДрТ Пошкодження кабелю	Бригада 3 ремонтів
24.11.2015 Вт 09:00	с.Шашливе, Мисливська, 19 кв. 1	Соловйова Єкатерина Феофанівна - (22922) с.Шашливе, Мисливська, 19 кв. 1 IP: 10.10.0.29	Выполнено прострочено	Ремонт ДрТ Немає сигналу	Бригада 3 ремонтів
26.11.2015 Чт 13:00	Київ, Таллер, 5А кв. 85	Давидова Платона Рубенівна - (22643) Київ, Таллер, 5А кв. 85 IP: 10.25.10.83	Выполнено прострочено	Ремонт ДрТ Немає сигналу	Бригада 3 ремонтів
27.11.2015 Пт 12:00	Бровари, Київська, 8 кв. 1	Русаків Михайло Максимович - (22836) Бровари, Київська, 8 кв. 1 IP: 10.26.0.3	Выполнено прострочено	Ремонт Радио	Бригада 3 ремонтів
27.11.2015 Пт 12:00	Бровари, Макаренка, 6 кв. 1	Купаліна Людмила Натанівна - (22840) Бровари, Макаренка, 6 кв. 1 IP: 10.26.0.7 05047714 (SMS) 606407 (MMS)	Выполнено прострочено	Ремонт Радио Обривається сигнал	Бригада 3 ремонтів
25.11.2015 Ср 15:00	с.Княжичі, Київська, 112 кв. 1	Іванова Тамара Миронівна - (22870) с.Княжичі, Київська, 112 кв. 1 IP: 10.27.0.7 541193 (MMS)	Выполнено прострочено	Ремонт Радио Розгорнуто антену	Бригада 3 ремонтів

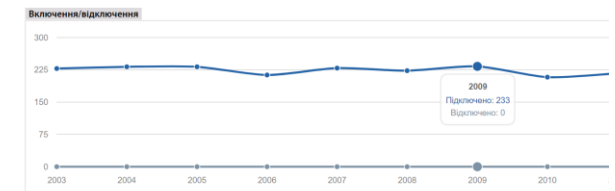

#	Адреса	2003		2004		2005		2006		2007		2008		2009		2010														
		+	-	+	-	+	-	+	-	+	-	+	-	+	-	+	-													
1.	Київська область	228		228		232		460		232		692		213		905		229		1134		223		1357		233		1590		208
1.1.	Бериславський	2		2		5		9		4		13		8		21		4		25		8		33		7		40		8
1.1.1.	с.Пропіски	1		1		3		5		1		5		1		6				6				6						6
1.1.2.	с.Чубицьке											2		2		1		3		3		1		4		2				2
1.1.3.	с.Шашливе	2		2		3		5		2		8		5		13		3		16		8		24		9		10		4
1.2.	Броварський	2		2		2		5		4		4		1		5		4		9		3		12		1				1
1.2.1.	Бровари	1		1		2		3		3		3		1		4		1		5		1		6		1				1
1.2.2.	с.Княжичі	1		1		1		1		1		1		1		1		1		1		1		4		2				4
1.3.	Київ	223		223		224		447		228		675		205		800		224		1104		211		1315		223		1538		201
1.3.1.	Лі мікрорайон	2		2		11		18		6		24		16		40		8		48		8		56		14		20		9
1.3.2.	Березини	9		9		12		21		10		31		12		43		12		55		12		62		11		28		9
1.3.3.	Дніпровський	4		4		2		6		4		10		2		12		4		16		2		18		2		20		1
1.3.4.	Русанівка	201		201		199		450		208		610		125		783		200		983		189		1124		196		1320		182
	Разом	228		228		232		460		232		692		213		905		229		1134		223		1357		233		1590		208

PERSONELL AND TRANSPORT

- Accounting of divisions and departments according to a hierarchical structure of any complexity.
- Customised employee cards with the ability to add files and photos.
- Ability to assign an employee to several departments with different roles (manager, deputy, employee) and positions.
- Timesheet.
- Work sheets and salary calculation by tasks (tickets) per employee and unit.
- System of bonuses and fines.
- Accounting for transport and car fleet.

Module for GPS operation

- Control the location of employees and vehicles.
- Supports various models of trackers (including software trackers (Android/iOS)).
- Displaying the location on the map, which allows, among other things, to find the employee closest to the accident site.
- Recording and displaying reports and route sheets for transport (time, speed, distance, addresses, etc.).

ПЕРСОНАЛ / ПІДРОЗДІЛИ

+ Додати підрозділ
📅 Календар призначень

EN

- Administration (2)
 - Call-center (4)
 - IT-department (3)
 - Bookkeeping (2)
 - Marketing department (3)
 - Housewifely department (1)
 - Storehouse (3)
 - Juridical department (1)
 - Technical department (1)
 - Team 1 (2)
 - Team 2 (2)
 - Repair team (2)

BG

- Администрация БС (2)
 - Call-център (4)
 - IT-отдел (3)
 - Счетоводство (2)
 - Отдел продажби (3)
 - Отдел за планиране и развитие (2)
 - Склад (3)
 - Технически отдел (1)
 - Бригада за возачи №1 (2)
 - Бригада за возачи №2 (2)

ПЕРСОНАЛ / ТАБЕЛЪ РОБИТ

← Повернитесь на главную

УСІ 3d 02.03.2024 📅 Так

← Березень 2024 →

№	Співробітник	Посада	02.03.2024																	
			01 Пт	02 Сб	03 Нд	04 Пн	05 Вт	06 Ср	07 Чт	08 Пт	09 Сб	10 Нд	11 Пн	12 Вт	13 Ср	14 Чт	15 Пт	16 Сб	17 Нд	18 Пн
1	Abramson A.	Millwright																		
2	Ardteriv A.	Millwright																		
3	Ardlington B.	Cleaner																		
4	Adrian B.	IT department chief																		
5	Backler B.	Storehouse chief																		
6	Bishop D.	Call center operator																		
7	Carnishell D.	Call center chief																		
8	Clayton E.	Main bookkeeper																		
9	Courtney D.	Director																		
10	Donovan L.	Millwright																		

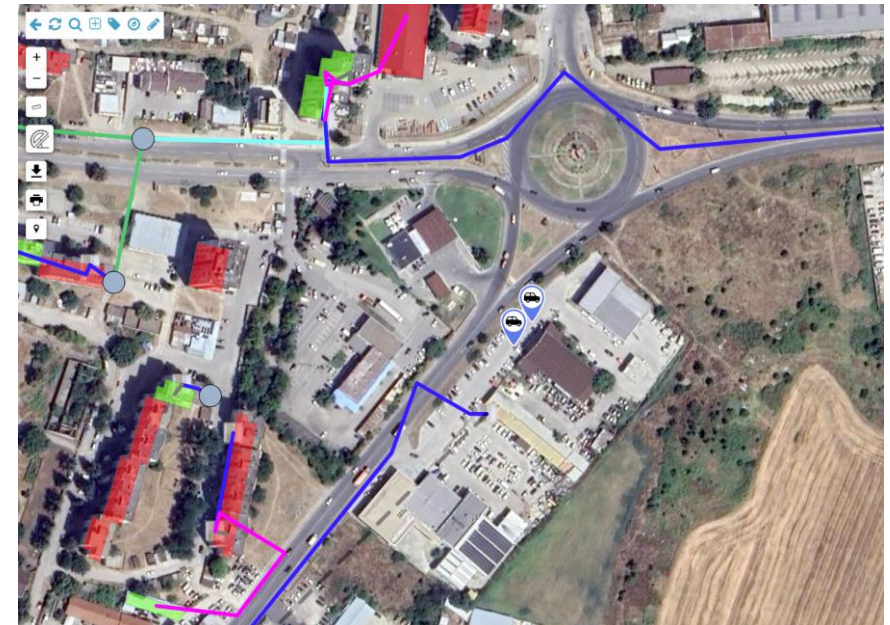

WAREHOUSE / ACCOUNTING / INVENTORIES

- Catalogue of goods and suppliers.
- Different warehouses and materially responsible persons.
- Different objects and types of accounting (sub-accounting). Serial and inventory numbers. Barcodes. Barcode and QR code generation.
- Interaction of goods and materials and equipment.
- Statements and reports.
- Acceptance and transfer invoices.
- Accounting for accountability.
- Accounting of goods and materials sold to customers.

- An existing "knowledge base" of typical inventory items.
- The ability to integrate several items of inventory into a new product (for example, a pipe and a crane that are required together on an application).
- Reserves in warehouses and notifications about the need for replenishment.
- Generate reports on a specific type of inventories.
- Setting up user rights for the Warehouse module: only performing warehouse operations, or additionally the right to write off, delete items, etc.

СКЛАД / ТМЦ

+ Додати ТМЦ (прихід)

Фільтри відображення

Місцезнаходження	Контрагент	Тип обліку	Категорія
Абоненти	Склад №1	Відповідальне зберігання	Cabel
Будівлі		Облік проданого	IP-cam
Будівля (з об'єктами)		Оренда	IP-phone
Завдання		Підзвіт довгий	Mediaconverter
Кабельні лінії		Підзвіт короткий	OLT
Постачальники		Розстрочка	ONU
Склади		ТМЦ	Printers
Співробітники			Radio
Списано			Server
Споруди зв'язку			SFP

ще

Фільтр

Скасування

СКЛАД

[Вернуться в список](#)

Карточка ТМЦ

#: 1272
Наименование: Dahua DH-IPC-HDW1120SP-0280B
Категория: IP-cam
Документ:
К-во: 1 шт.
Серийный №:
Инв. №:
Штрихкод:
Общая стоимость: 70.00 \$
Местонахождение: 206030000655
Объекты размещения

Заметки:

[Редактировать](#)
[QR-код](#)
[Карточка устройства](#)

Запрещено перемещать оборудование с используемыми портами. Очистите коммутацию

[Прикрепить файл](#)

Операции с ТМЦ

№	Дата	Откуда	Куда	К-во (общее)	Сумма (общая)	Заметки
1	01.07.2017 16:15	Поставщики	Склад	5	350.00	
2	01.07.2017 16:19	Склад	Объекты размещения	1	70.00	



USERSIDE.BUSINESS



USERSIDE.BUSINESS
www.userside.eu